



GR-1000XLL-4

100 Ton (90.7 Metric Ton) Capacity

Form NO. GR-1000-4-00102/US-03

HYDRAULIC ROUGH TERRAIN CRANE

DIMENSIONS

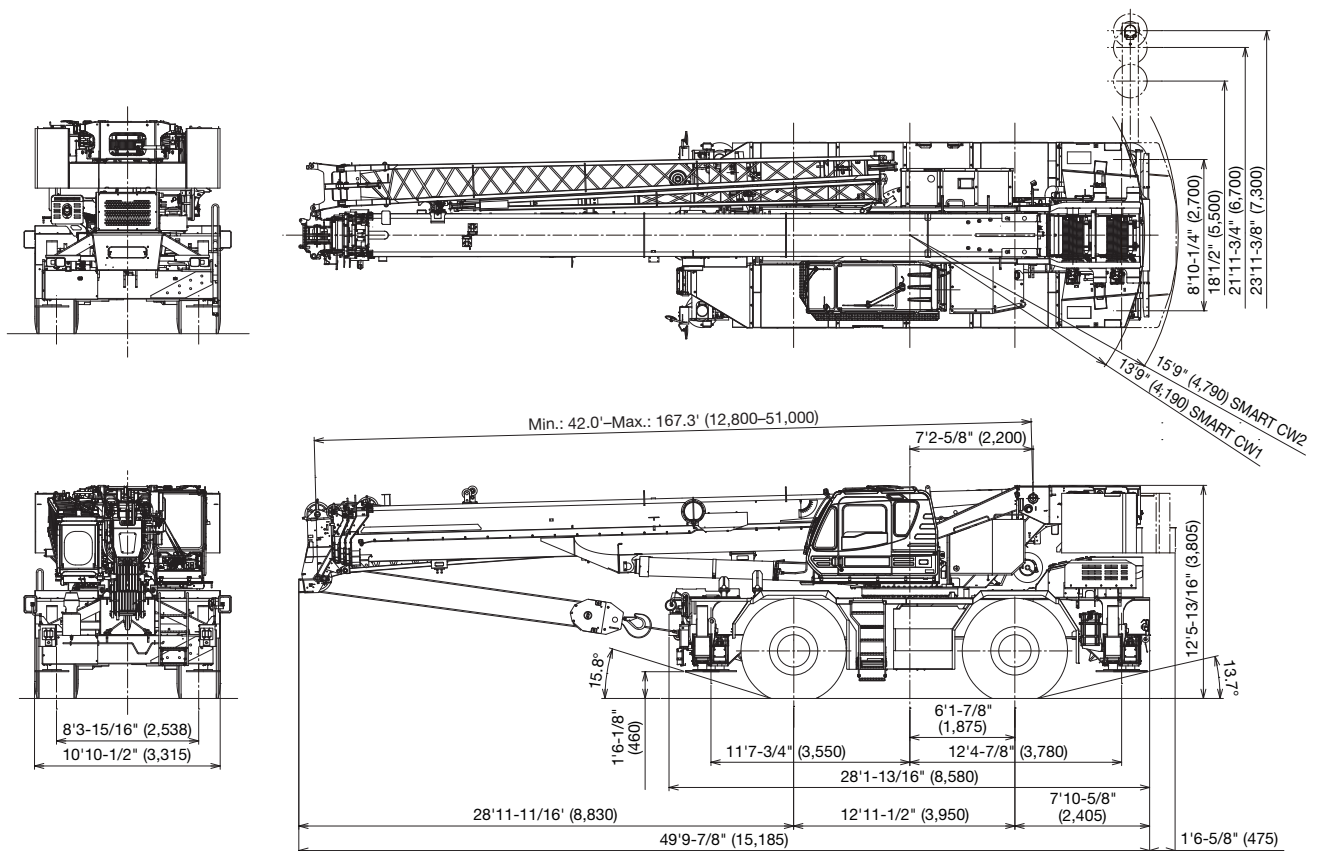

Note: Dimension is with boom angle at -1.5 degree.
() Reference dimensions in mm.

GENERAL DIMENSIONS

	Feet	Meters		Feet	Meters
Turning radius (29.5-25 Tires)			Overall length	approx. 49' 9-7/8"	15.185
4 wheel steer	22' 4"	6.8	Overall width	approx. 10' 10-1/2"	3.315
2 wheel steer	35' 9-3/32"	10.9	Overall height	approx. 12' 5-13/16"	3.805

CRANE SPECIFICATIONS

BOOM

5 section full power synchronized telescoping boom, 42.0'-167.3' (12.8 m-51.0 m), of round box construction with 7 sheaves, 17-5/16" (0.44 m) root diameter, at boom head.

The synchronization system consists of 2 telescope cylinders, an extension cable and retraction cable. Hydraulic cylinder fitted with holding valve. 2 easily removable wire rope guards, rope dead end provided on both sides of boom head. Boom telescope sections are supported by wear pads both vertically and horizontally. Extension speed 125.3' in 170 seconds.

BOOM ELEVATION - By a double acting hydraulic cylinder with holding valve. Elevation -1.5°-80.5°, combination controls for hand or foot operation. Boom angle indicator. Automatic speed reduction and slow stop function. Boom raising speed 20° to 60° in 46 seconds.

JIB - 2 stage bi-fold lattice type, 3.5°, 25° or 45° offset (tilt type). Single sheave, 15-5/8" (0.396 m) root diameter, at the head of both jib sections. Stored alongside base boom section. Jib length is 33.2' (10.1 m) or 58.1' (17.7 m). Assistant cylinders for mounting and stowing, controlled at right side of superstructure. Self stowing jib mounting pins.

AUXILIARY LIFTING SHEAVE (SINGLE TOP)

Single sheave, 15-5/8" (0.396 m) root diameter. Mounted to main boom head for single line work (stowable).

ANTI-TWO BLOCK - Pendant type over-winding cut out device with audio-visual (FAILURE lamp/BUZZER) warning system.

SLEWING

Hydraulic axial piston motor through planetary slewing speed reducer. Continuous 360° full circle slewing on ball bearing turn table at 1.5 min⁻¹ {rpm}. Equipped with manually locked/released slewing brake. A 360° positive slewing lock for pick and carry and travel modes, manually engaged in cab. Twin slewing system: Free slewing or lock slewing controlled by selector switch on front console.

WINCH

MAIN WINCH - Variable speed type with grooved drum driven by hydraulic axial piston motor through speed reducer. Power load lowering and raising. Equipped with automatic brake (neutral brake) and counterbalance valve. Controlled independently of auxiliary winch. Equipped with cable follower and drum rotation indicator.

DRUM - Grooved 14-1/4" (0.362 m) root diameter x 26-13/16" (0.681 m) wide. Wire rope: 935' of 3/4" diameter rope (285 m of 19 mm). Drum capacity: 1135' (346 m) 7 layers. Maximum single line pull: 1st layer 20,000 lbs (9,090 kg). Maximum permissible line pull wire strength: 14,600 lbs (6,600 kg).

AUXILIARY WINCH - Variable speed type with grooved drum driven by hydraulic axial piston motor through speed reducer. Power load lowering and raising. Equipped with automatic brake (neutral brake) and counterbalance valve. Controlled independently of main winch. Equipped with cable follower and drum rotation indicator.

DRUM - Grooved 14-1/4" (0.362 m) root diameter x 26-13/16" (0.681 m) wide. Wire rope: 482' of 3/4" diameter rope (147 m of 19 mm). Drum capacity: 1135' (346 m) 7 layers. Maximum single line pull: 1st layer 20,000 lbs (9,090 kg). Maximum permissible line pull wire strength: 14,600 lbs (6,600 kg).

WIRE ROPE - Non-rotating 3/4" (19 mm) P·S (19) + 39 x P·7 Breaking Strength 72,800 lbs (33,000 kg)

HOOK BLOCKS

100 ton (90.7 metric ton)-8 sheaves with swivel hook and safety latch, for 3/4" (19 mm) wire rope.

7.3 ton (6.6 metric ton) - Weighted hook with swivel and safety latch, for 3/4" (19 mm) wire rope.

COUNTERWEIGHT

Self-removable counterweight 24,700 lbs (11,200 kg)

HYDRAULIC SYSTEM

PUMPS - 2 variable piston pumps for crane functions. Tandem gear pump for steering slewing and other hydraulic systems. Powered by carrier engine. Pump disconnect for crane is engaged/disengaged by rotary switch from operator's cab.

CONTROL VALVES - Multiple valves actuated by pilot pressure with integral pressure relief valves.

RESERVOIR - 210 gallon (795 lit.) capacity. External sight level gauge.

FILTRATION - BETA10=10 return filter, full flow with bypass protection, located inside of hydraulic reservoir. Accessible for easy replacement.

OIL COOLER - Air cooled fan type.

CAB AND CONTROLS

Both crane and drive operations can be performed from one cab mounted on rotating superstructure.

20° tilt, Left side, 1 man type, steel construction with sliding door access and safety glass windows opening at side. Door window is powered control. Windshield glass window and roof glass window are shatter-resistant. Tilt-telescoping steering wheel. Adjustable control lever stands for slewing, boom elevating, boom telescoping, auxiliary winch and main winch. Control lever stands can change neutral positions and tilt for easy access to cab. 3 way adjustable operator's seat with high back, headrest and armrest. Engine throttle knob. Foot operated controls: boom elevating boom telescoping, service brake and engine throttle. Hot water cab heater and air conditioning.

Dash-mounted Instrument panel, Multi Function Display, Starter switch (engine start/stop), 12 V power outlet, USB port, drive selector switch, parking brake switch, steering mode select switch, power window switch, pump engaged/disengaged switch, slewing brake switch, telescoping/auxiliary winch select switch, outrigger controls, free slewing/lock slewing selector switch, air conditioning control switch.

Instruments panel - Torque converter oil temperature, engine water temperature, air pressure, fuel, speedometer, tachometer, hour meter and odometer/tripmeter.

Multi Function Display - DEF level gauge, Fuel consumption monitor.

Tadano electronic LOAD MOMENT INDICATOR system (AML-E2) including:

- Control lever lockout function with audible and visual pre-warning
- Number of parts of line
- Boom position indicator
- Outrigger state indicator
- Slewing angle
- Boom angle / boom length / jib offset angle / jib length / load radius / rated lifting capacities / actual loads read out
- Potential lifting height
- Ratio of actual load moment to rated load moment indication
- Automatic Speed reduction and slow stop function on boom elevation and slewing
- Working condition register switch
- Load radius / boom angle / tip height / slewing range preset function
- External warning lamp
- Tare function
- Main Hydraulic oil pressure
- Fuel consumption monitor

- Main winch / auxiliary winch select
- Drum rotation indicator (audible and visible type) main and auxiliary winch
- On rubber indicator

TADANO AML-E2 monitors outrigger extended length and automatically programs the corresponding "RATED LIFTING CAPACITIES" table.

Operator's right hand console includes transmission gear selector, slewing lock lever and sight level bubble.

Upper console includes, roof washer and wiper switch, emergency outrigger set up key switch, jib equipped / removed select switch, high speed winch (main / aux) switch, Cab tilt switch, Pump disconnect enable switch and boom emergency telescoping switch (2nd and 3rd-top).

NOTE: Each crane motion speed is based on unladen conditions.

CARRIER SPECIFICATIONS

TYPE - Rear engine, left hand steering, driving axle 2-way selected type by manual switch, 4 x 2 front drive, 4 x 4 front and rear drive.

FRAME - High tensile steel, all welded mono-box construction.

TRANSMISSION - Electronically controlled full automatic transmission. Torque converter driving full powershift with driving axle selector. 6 forward and 2 reverse speeds, constant mesh.

- 3 speeds - high range - 2 wheel drive; 4 wheel drive
- 3 speeds - low range - 4 wheel drive

TRAVEL SPEED - 22 mph (36 km/h)

GRADEABILITY (tanθ) - 84% (at stall), 57%*

* Machine should be operated within the limit of engine crankcase design (30°: Cummins B6.7)

AXLE - Front: Full floating type, steering and driving axle with planetary reduction. Rear: Full floating type, steering and driving axle with planetary reduction and non-spin rear differential.

STEERING - Hydraulic power steering controlled by steering wheel. Four steering modes available: 2 wheel front, 2 wheel rear, 4 wheel coordinated and 4 wheel crab.

SUSPENSION - Front: Rigid mounted to frame. Rear: Pivot mounted with hydraulic lockout device.

ENGINE

Model	Cummins B6.7
Type	Direct injection diesel
No. of cylinders	6
Combustion	4 cycle, turbo charged and after cooled
BoreXStroke, in. (mm)	4.212 X 4.882 (107 X 124)
Displacement, cu. in (liters)	409 (6.7)
Air inlet heater	24 volt preheat
Air cleaner	Dry type, replaceable element
Oil filter	Full flow with replaceable element
Fuel filter	Full flow with replaceable element
Fuel tank, gal. (liters)	79.2 (300), right side of carrier
Cooling	Liquid pressurized, recirculating by-pass

BRAKE SYSTEMS - Service: Air over hydraulic disc brakes on all 4 wheels. Parking / Emergency: Spring applied-air released brake acting on input shaft of front axle. Auxiliary: Electro-pneumatic operated exhaust brake.

TIRES - 29.5-25 36PR (OR) Air pressure: 68 psi (470 kPa)
29.5-25 40PR (OR) Air pressure: 67 psi (465 kPa)

OUTRIGGERS - Four hydraulic, beam and jack outriggers. Vertical jack cylinders equipped with integral holding valve. Each outrigger beam and jack is controlled independently from cab. Beams extend to 23' 11-3/8" (7.3 m) center-line and retract to within 10' 10-1/2" (3.315 m) overall width with floats. Outrigger jack floats are attached thus eliminating the need of manually attaching and detaching them. Controls and sight bubble located in superstructure cab. Four outrigger extension lengths are provided with corresponding "RATED LIFTING CAPACITIES" for crane duty in confined areas.

- Min. Extension 8' 10-1/4" (2.7 m) center to center
- Mid. Extension 18' 1/2" (5.5 m) center to center
- Mid. Extension 21' 11-3/4" (6.7 m) center to center
- Max. Extension 23' 11-3/8" (7.3 m) center to center

Float size (Diameter) 1' 11- 5/8" (0.6 m)

Radiator	Fin and tube core, thermostat controlled
Fan, in. (mm)	Suction type, 9-blade, 28 (711) dia.
Starting	24 volt
Charging	24 volt system, negative ground
Battery	2-120 amp. Hour
Compressor, air, CFM (l /min)	17.0 CFM (481) at 2,400 rpm
Output, Max. HP (kW)	Gross 280 (209) at 2,200 rpm
Torque, Max. ft-lb (Nm)	850 (1,152) at 1,500 rpm
Capacity, gal. (liters)	
Cooling water	2.7 (10)
Lubrication	4.0 (15)
Fuel	79.2 (300)
DEF/AdBlue	15.0 (57)

STANDARD EQUIPMENT

- 5 section full power partially synchronized boom
42.0'-167.3' (12.8 m-51.0 m)
- 33.2' or 58.1' (10.1 m or 17.7 m) bi-fold lattice jib (tilt type)
with 3.5°, 25° or 45° pinned offsets and self storing pins.
- Quick reeving type bi-fold jib
- Anti-Two block device (overwind cutout)
- Winch drum camera with light
- LED work lights
- Variable speed main winch with grooved drum, cable follower, drum
rotation indicator (audible, visible and thumper type) and 935' of 3/4" cable.
- Variable speed auxiliary winch with grooved drum, cable follower, drum
rotation indicator (audible, visible and thumper type) and 482' of 3/4" cable.
- Auxiliary lifting sheave (single top) stowable
- 2-speed winch
- 100 ton (90.7 metric ton) hook block - 8 sheave with swivel hook
and safety latch for 3/4" (19 mm) wire rope
- 7.3 ton (6.6 metric ton) hook with swivel
- Tadano twin slewing system and 360° positive slewing lock
- Positive control
- Hydraulic oil cooler
- 3 way adjustable cloth seat with armrests, high back and seat belt
- Tilt-telescoping steering wheel
- Tinted safety glass and sun visor
- Front windshield wiper and washer
- Roof window wiper and washer
- Power window (cab door)
- 12V power outlet
- Ashtray
- Cab floor mat
- Pump disconnect in operator's cab
- Air conditioner (hot water heater and cooler)
- Full instrumentation package
- Self centering finger control levers with pilot control
- Control pedals for boom elevating and boom telescoping
- Low oil pressure / high water temp. warning device (visual)
- Air cleaner dust indicator
- Cup holder
- Battery disconnect
- USB port
- 20° tilt cab
- Wind speed indicator
- Emergency steering system
- Tadano electronic load moment indicator system (AML-E2)
- Boom angle indicator
- Outrigger extension length detector
- Electronic crane monitoring system
- Rear view camera
- Right front view camera
- Fenders
- Air dryer
- Complete highway light package
- Towing hooks-Front and rear
- Hook block tie down (front bumper)
- Weighted hook storage compartment
- Halogen head lamp
- Independently controlled outriggers
- Four outrigger extension positions
- Self-storing outrigger pads
- Electronic controlled automatic transmission driven by torque converter
- 4 X 4 X 4 drive / steer
- Non-spin rear differential
- Automatic rear axle oscillation lockout system
- 29.5-25 36 PR tires
- 29.5-25 40 PR tires
- Disc brakes
- Water separator with filter (high filtration)
- Back-up alarm
- 24 volt electric system
- Tool storage compartment
- Tire inflation kit
- Cummins B6.7 turbo charged
after cooled engine (280 HP) with exhaust brake
- Engine over-run alarm
- Lifting eyes
- Telematics (machine data logging and monitoring system)
with HELLO-NET via internet (availability depends on countries)
- Fuel consumption monitor
- Eco mode system
- Self-removable counterweight
- Radiator cover
- Clearance sonar (Rear side)
- Automatic pump disconnect
- Over unwinding prevention

HOISTING PERFORMANCE

LINE SPEEDS AND PULLS

Layer	Main or auxiliary hoist - 14'-1/4" (0.362 m) drum							
	Line speeds ¹				Line pulls Available ²			
	Low		High		Low		High	
	F.P.M	m/min	F.P.M	m/min	Lbs.	kgf	Lbs.	kgf
1st	278	84	387	118	20,000	9,090	14,400	6,520
2nd	302	92	421	128	18,100	8,230	13,000	5,900
3rd	327	99	456	139	16,600	7,520	11,900	5,390
4th	352	107	491	149	15,300	6,920	10,900	4,960
5th	377	115	526	160	14,100	6,410	10,100	4,600
6th	402	122	560	170	13,200	5,970	9,400	4,280
7th ³	427	130	595	181	12,300	5,590	8,800	4,010

- Maximum permissible line pull wire strength
14,600 lbs (6,600 kg).

¹ Line speeds based only on hook block, not loaded.
² Developed by machinery with each layer of wire rope, but not based
on rope strength or other limitation in machinery or equipment.
³ Seventh layer of wire rope are not recommended
for hoisting operations.

DRUM WIRE ROPE CAPACITIES

Wire rope layer	Main and auxiliary drum grooved lagging 3/4" (19 mm) wire rope			
	Rope per layer m		Total wire rope m	
	Feet	Meters	Feet	Meters
1	128.0	39.0	128.0	39.0
2	139.4	42.5	267.4	81.5
3	150.9	46.0	418.3	127.5
4	162.1	49.4	580.4	176.9
5	173.9	53.0	754.3	229.9
6	185.4	56.5	939.6	286.4
7	196.9	60.0	1,136.5	346.4

DRUM DIMENSIONS

	Inch	mm
Root diameter	14-1/4"	362
Length Flange diameter	26-13/16"	681
	25-7/8"	657

GR-1000XLL-4 WORKING RANGE CHART

SMART CW1 360° ROTATION

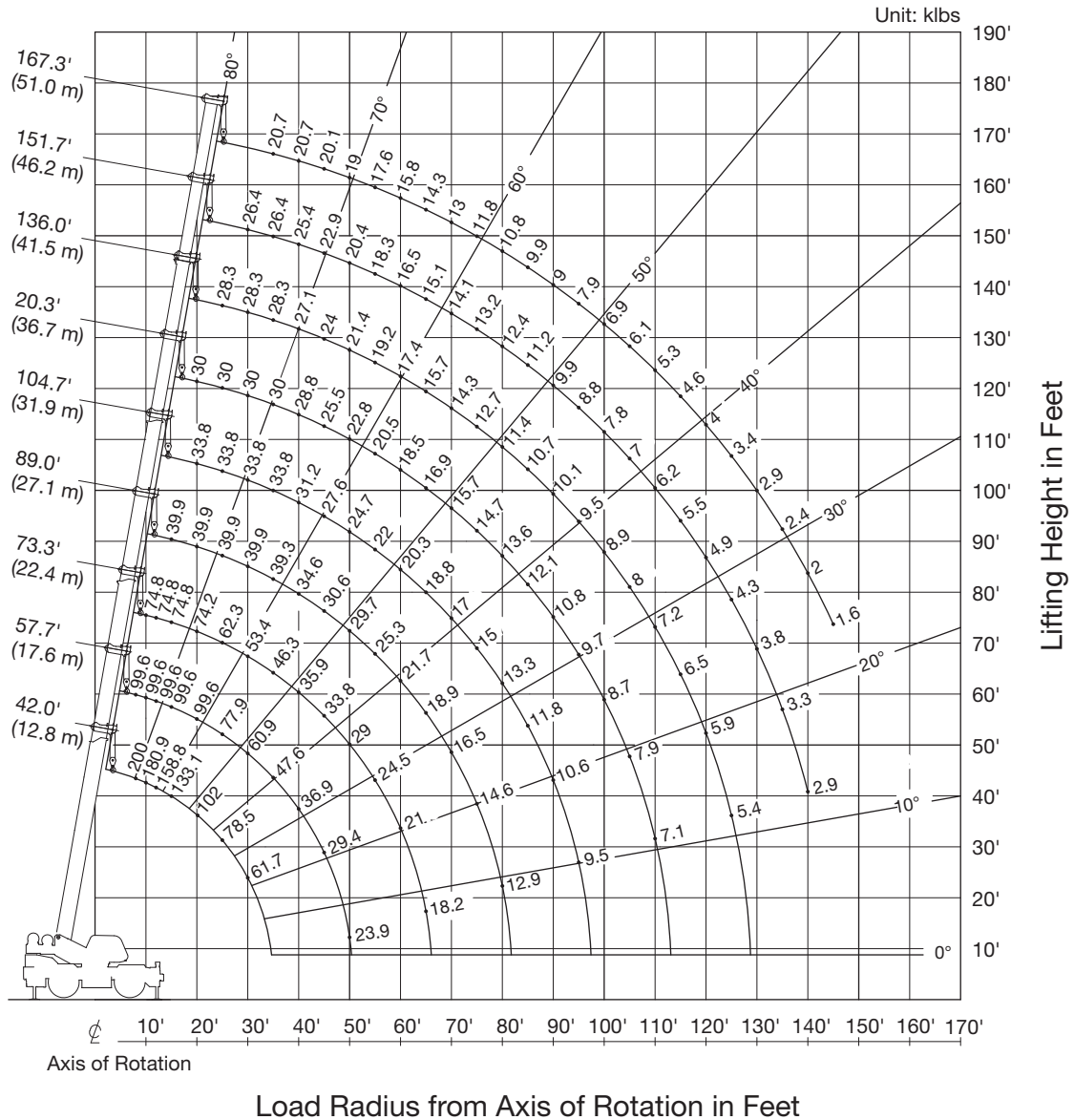

BOOM

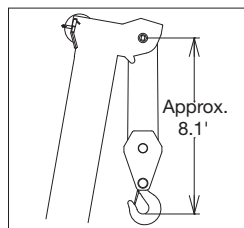

SINGLE TOP

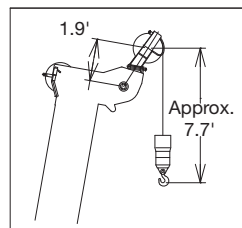

NOTE: Boom geometry shown is for unloaded condition and machine standing level on firm supporting surface. Boom deflection and subsequent radius and boom angle change must be accounted for when applying load to hook. When boom length is same as telescoping mode 1 and 2, it show large load.

GR-1000XLL-4 WORKING RANGE CHART

SMART CW2 360° ROTATION

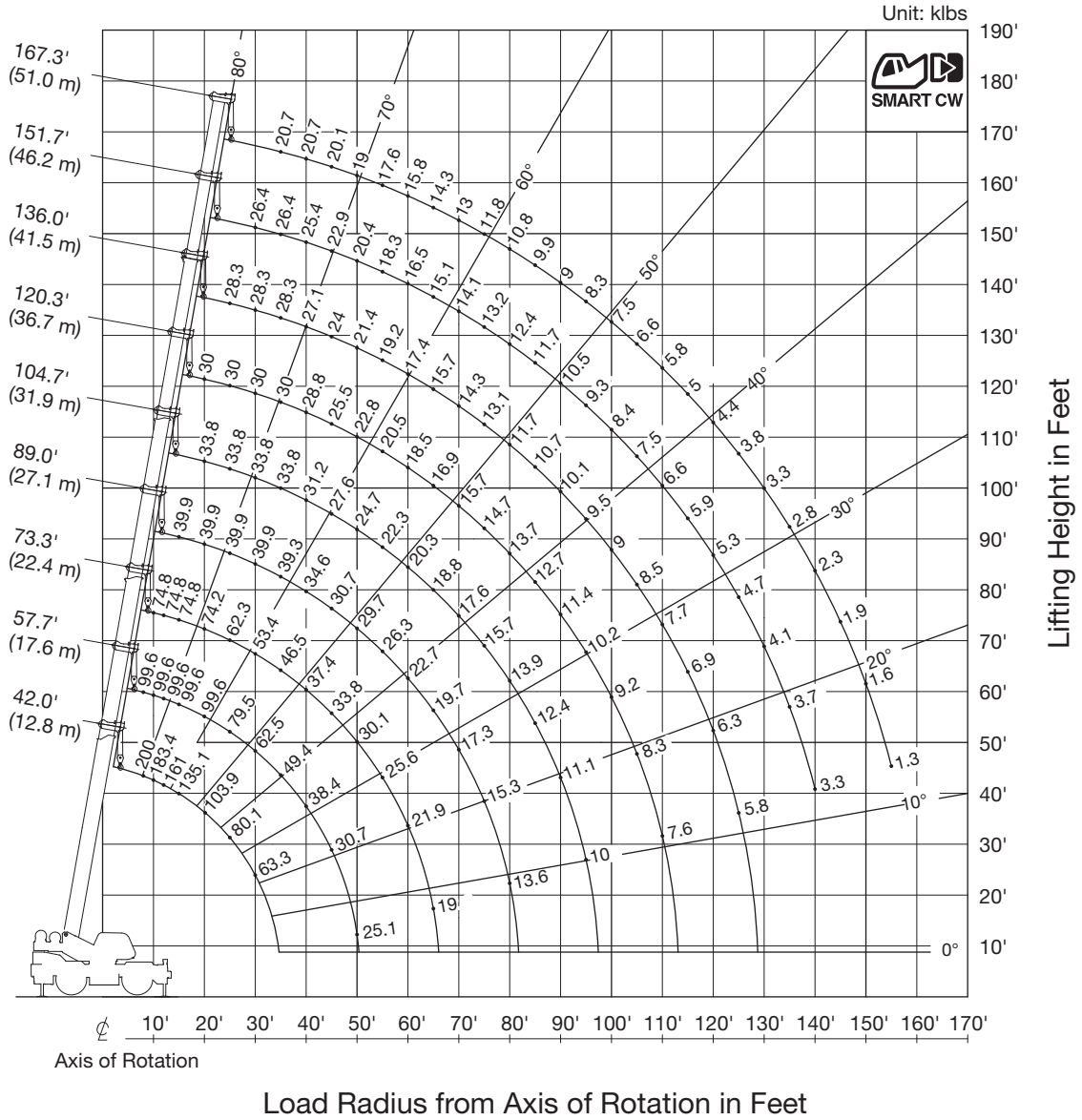

BOOM

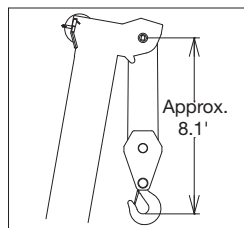

SINGLE TOP

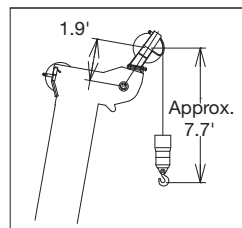

NOTE: Boom geometry shown is for unloaded condition and machine standing level on firm supporting surface. Boom deflection and subsequent radius and boom angle change must be accounted for when applying load to hook. When boom length is same as telescoping mode 1 and 2, it show large load.

GR-1000XLL-4 WORKING RANGE CHART

SMART CW2 SMART CHART

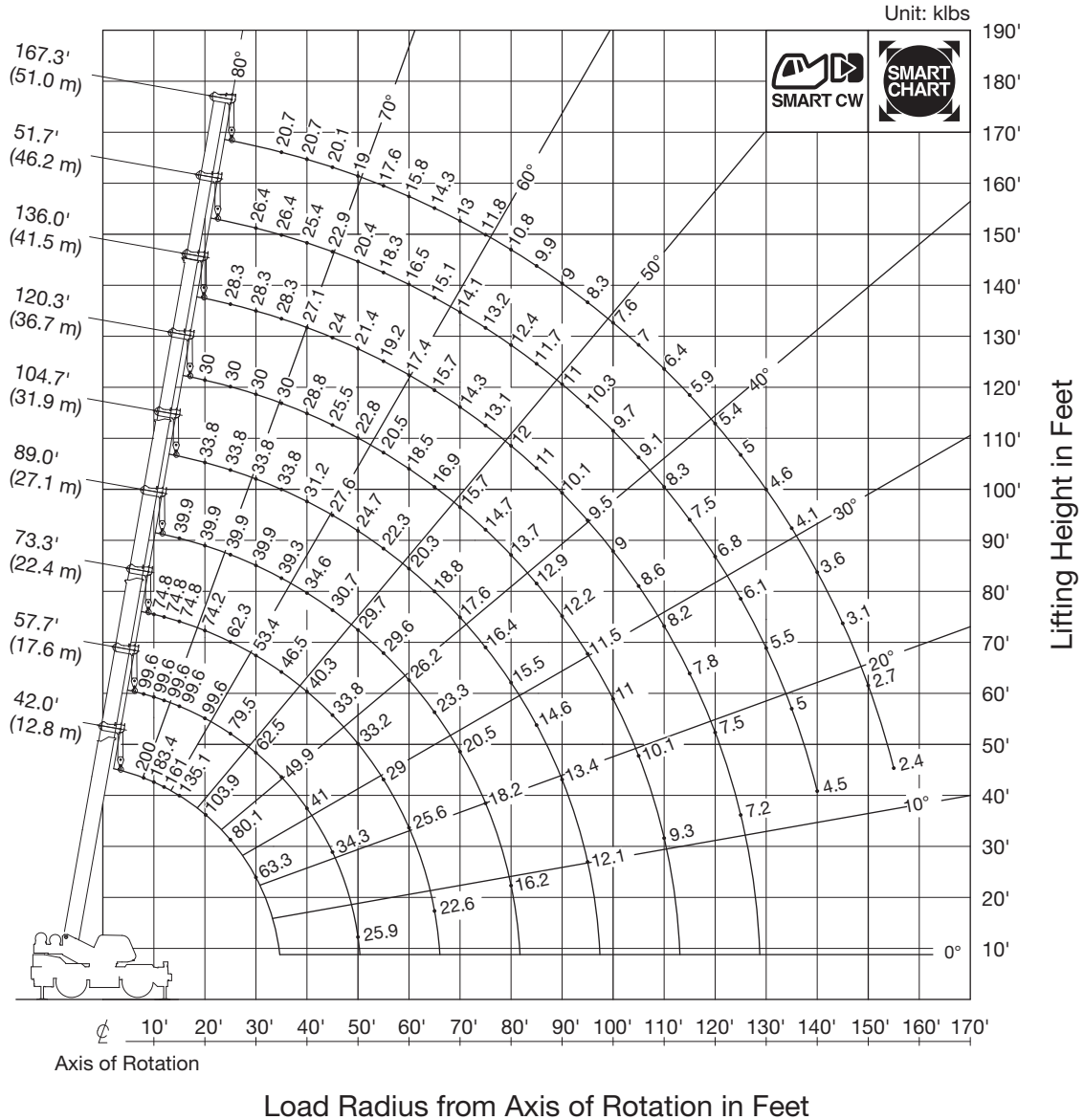

BOOM

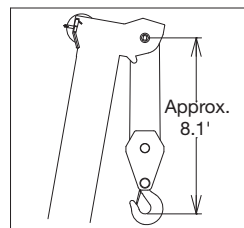

SINGLE TOP

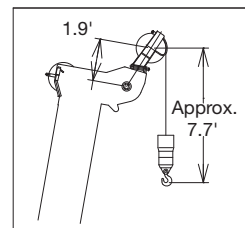

NOTE: Boom geometry shown is for unloaded condition and machine standing level on firm supporting surface. Boom deflection and subsequent radius and boom angle change must be accounted for when applying load to hook. When boom length is same as telescoping mode 1 and 2, it show large load.

GR-1000XLL-4 WORKING RANGE CHART

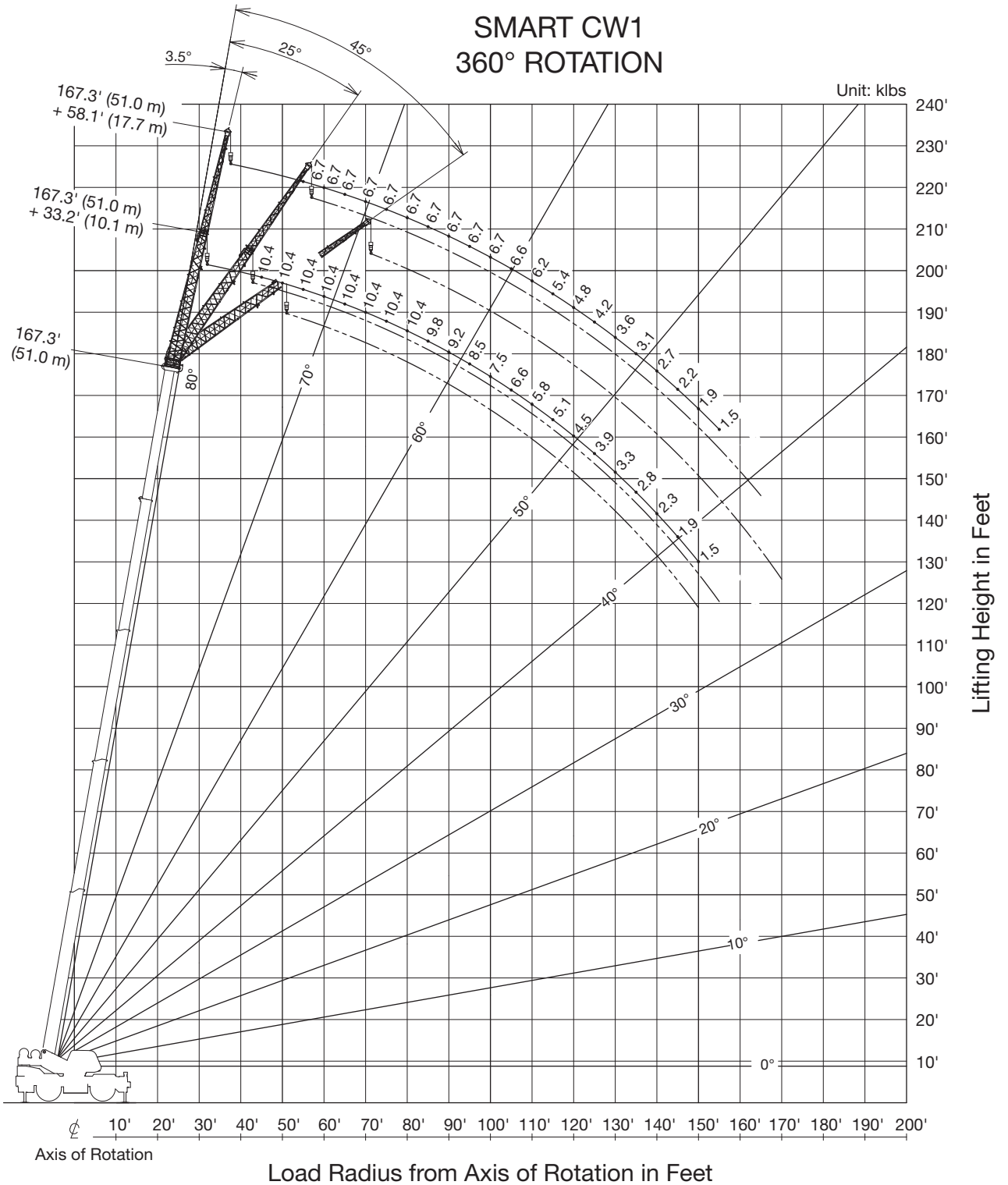

NOTE: Jib geometry shown are for unloaded condition and machine standing level on firm supporting surface. Boom deflection and subsequent radius and boom angle change must be accounted for when applying load to hook.

JIB

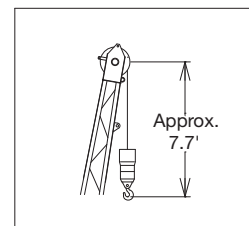

GR-1000XLL-4 WORKING RANGE CHART

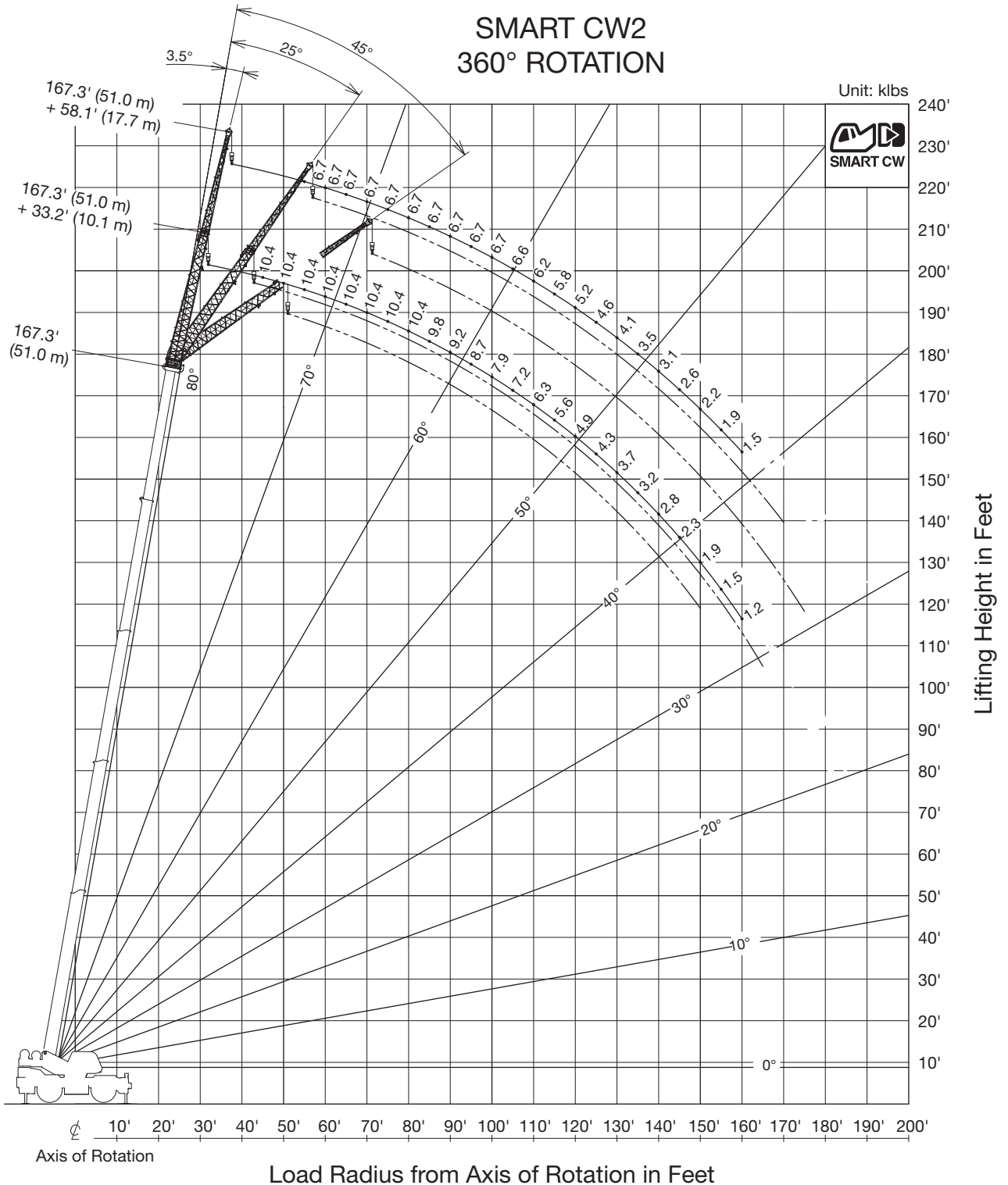

NOTE: Jib geometry shown are for unloaded condition and machine standing level on firm supporting surface. Boom deflection and subsequent radius and boom angle change must be accounted for when applying load to hook.

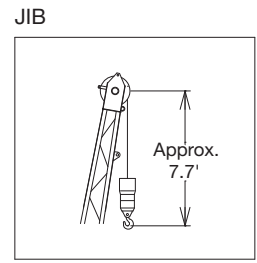

GR-1000XLL-4 WORKING RANGE CHART

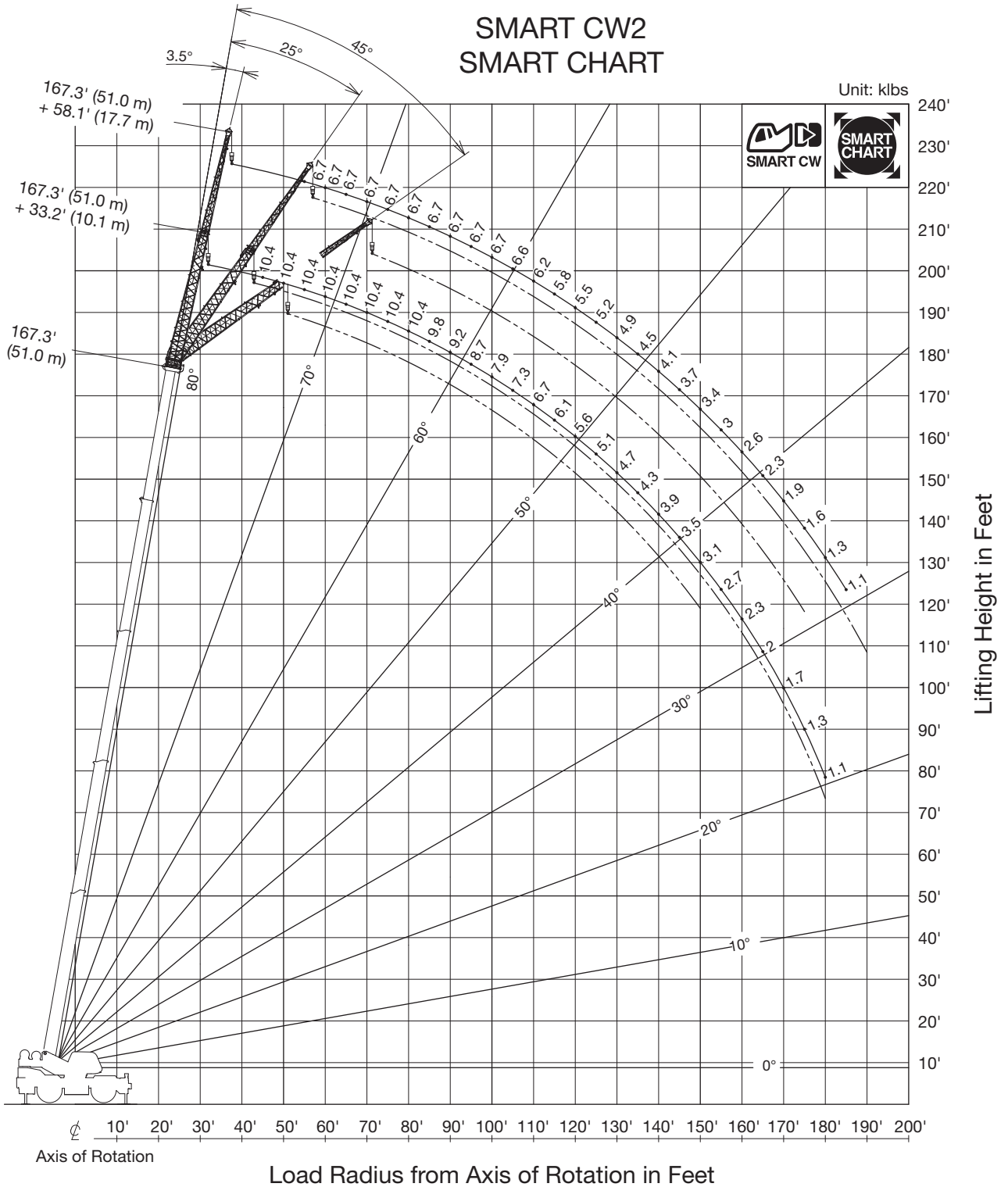

NOTE: Jib geometry shown are for unloaded condition and machine standing level on firm supporting surface. Boom deflection and subsequent radius and boom angle change must be accounted for when applying load to hook.

JIB

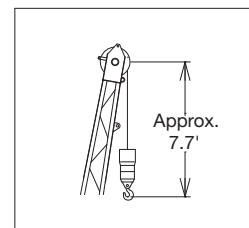

GR-1000XLL-4 RATED LIFTING CAPACITIES (IN POUNDS)

COUNTERWEIGHT 24,700lbs (11.2 t) ON OUTRIGGERS FULLY EXTENDED 23' 11-3/8" (7.3 m) SPREAD 360° ROTATION SMART CW1																
B \ A	42.0' (12.8 m)	57.7' (17.6 m)	73.3' (22.4 m)		89.0' (27.1 m)		104.7' (31.9 m)		120.3' (36.7 m)		136.0' (41.5 m)		151.7' (46.2 m)		167.3' (51 m)	
8	200,000	99,600														
10	180,900	99,600	74,800	33,800												
12	158,800	99,600	74,800	33,800												
15	133,100	99,600	74,800	33,800	39,900	29,700										
20	102,000	99,600	74,200	33,800	39,900	29,700	33,800	27,700	30,000	27,600						
25	78,500	77,900	62,300	33,800	39,900	29,700	33,800	27,700	30,000	27,600	28,300	27,500				
30	61,700	60,900	53,400	33,800	39,900	29,700	33,800	27,700	30,000	27,600	28,300	26,100	26,400	24,100		
35		47,600	46,300	33,800	39,300	29,700	33,800	27,700	30,000	27,400	28,300	23,900	26,400	23,600	20,700	
40		36,900	35,900	33,800	34,600	29,700	31,200	27,700	28,800	25,000	27,100	21,500	25,400	22,000	20,700	
45		29,400	28,500	33,800	30,600	29,700	27,600	26,300	25,500	23,000	24,000	19,500	22,900	20,500	20,100	
50		23,900	23,000	29,000	25,000	29,700	24,700	23,900	22,800	21,200	21,400	17,800	20,400	19,100	19,000	
55			18,800	24,500	20,800	25,300	21,800	22,000	20,500	19,800	19,200	16,300	18,300	17,600	17,600	
60			15,400	21,000	17,400	21,700	18,400	20,300	18,500	18,200	17,400	15,000	16,500	16,200	15,800	
65			12,800	18,200	14,600	18,900	15,700	18,800	16,400	16,900	15,700	14,000	14,900	15,100	14,300	
70					12,300	16,500	13,400	17,000	14,100	15,700	14,300	13,000	13,600	14,100	13,000	
75					10,400	14,600	11,400	15,000	12,200	14,700	12,700	12,100	12,400	13,200	11,800	
80					8,800	12,900	9,800	13,300	10,500	13,600	11,000	11,400	11,300	12,400	10,800	
85								8,400	11,800	9,100	12,100	9,600	10,700	10,000	11,200	9,900
90								7,200	10,600	7,900	10,800	8,400	10,100	8,800	9,900	9,000
95								6,100	9,500	6,800	9,700	7,300	9,500	7,600	8,800	7,900
100										5,800	8,700	6,300	8,900	6,700	7,800	6,900
105										5,000	7,900	5,500	8,000	5,800	7,000	6,100
110										4,300	7,100	4,700	7,200	5,000	6,200	5,300
115												4,000	6,500	4,300	5,500	4,600
120												3,400	5,900	3,700	4,900	4,000
125												2,900	5,400	3,200	4,300	3,400
130														2,700	3,800	2,900
135														2,200	3,300	2,400
140														1,800	2,900	2,000
145																1,600
D	0°								10°	0°	12°	0°	15°	13°	26°	
Telescoping mode	1, 2	1	1	2	1	2	1	2	1	2	1	2	1	2	1, 2	
2nd Boom	0	50	100	0	100	0	100	0	100	0	100	0	100	50	100	
3rd Boom	0	0	0	33	16	50	33	67	50	83	67	100	83	100	100	
4th Boom	0	0	0	33	16	50	33	67	50	83	67	100	83	100	100	
Top Boom	0	0	0	33	16	50	33	67	50	83	67	100	83	100	100	

COUNTERWEIGHT 24,700lbs (11.2 t) ON OUTRIGGERS FULLY EXTENDED 23' 11-3/8" (7.3 m) SPREAD 360° ROTATION SMART CW1																														
C \ A	42.0' (12.8 m)		57.7' (17.6 m)		73.3' (22.4 m)		89.0' (27.1 m)		104.7' (31.9 m)		120.3' (36.7 m)		136.0' (41.5 m)																	
	B	B	B	B	B	B	B	B	B	B	B	B	B	B	B	B														
0°	35.2	19,700	50.7	10,900	66.1	4,600	66.1	9,500	81.7	3,200	81.8	6,700	97.2	1,800	97.2	5,100														
Telescoping mode	1, 2		1		1		2		1		2		1		2		2													

A: Boom length in feet
 B: Load radius in feet
 C: Loaded boom angle (°)
 D: Minimum boom angle (°) for indicated length (no load)

NOTE: The lifting capacity data stored in the LOAD MOMENT INDICATOR (AML-E2) is based on the standard number of parts of line listed in the chart. Standard number of parts of line for each boom length should be according to the following table.

Boom length in feet (meters)	42.0' (12.8 m)	42.0' to 73.3' (12.8 m to 22.4 m)	73.3' to 167.3' (22.4 m to 51 m)	Single top jib
Telescoping mode	1, 2	1	2	1, 2
Number of parts of line	16	8	4	1

GR-1000XLL-4 RATED LIFTING CAPACITIES (IN POUNDS)

SMART CW		COUNTERWEIGHT 24,700lbs (11.2 t) ON OUTRIGGERS FULLY EXTENDED 23' 11-3/8" (7.3 m) SPREAD 360° ROTATION SMART CW2																			
		A	42.0' (12.8 m)		57.7' (17.6 m)		73.3' (22.4 m)		89.0' (27.1 m)		104.7' (31.9 m)		120.3' (36.7 m)		136.0' (41.5 m)		151.7' (46.2 m)		167.3' (51 m)		
B																					
8		200,000		99,600																	
10		183,400		99,600	74,800	33,800															
12		161,000		99,600	74,800	33,800															
15		135,100		99,600	74,800	33,800	39,900	29,700													
20		103,900		99,600	74,200	33,800	39,900	29,700	33,800	27,700											
25		80,100		79,500	62,300	33,800	39,900	29,700	33,800	27,700	30,000	27,600									
30		63,300		62,500	53,400	33,800	39,900	29,700	33,800	27,700	30,000	27,600	28,300	27,500							
35				49,400	46,500	33,800	39,300	29,700	33,800	27,700	30,000	27,400	28,300	23,900	26,400	23,600	20,700				
40				38,400	37,400	33,800	34,600	29,700	31,200	27,700	28,800	25,000	27,100	21,500	25,400	22,000	20,700				
45				30,700	29,800	33,800	30,700	29,700	27,600	26,300	25,500	23,000	24,000	19,500	22,900	20,500	20,100				
50				25,100	24,100	30,100	26,200	29,700	24,700	23,900	22,800	21,200	21,400	17,800	20,400	19,100	19,000				
55					19,800	25,600	21,800	26,300	22,300	22,000	20,500	19,800	19,200	16,300	18,300	17,600	17,600				
60					16,400	21,900	18,300	22,700	19,300	20,300	18,500	18,200	17,400	15,000	16,500	16,200	15,800				
65					13,600	19,000	15,400	19,700	16,500	18,800	16,800	16,900	15,700	14,000	14,900	15,100	14,300				
70							13,100	17,300	14,100	17,600	14,900	15,700	14,300	13,000	13,600	14,100	13,000				
75							11,100	15,300	12,100	15,700	12,900	14,700	13,100	12,100	12,400	13,200	11,800				
80							9,400	13,600	10,400	13,900	11,200	13,700	11,700	11,400	11,300	12,400	10,800				
85										9,000	12,400	9,700	12,700	10,200	10,700	10,400	9,900				
90										7,700	11,100	8,400	11,400	9,000	10,100	9,300	10,500	9,000			
95										6,600	10,000	7,300	10,200	7,800	9,500	8,200	9,300	8,300			
100												6,300	9,200	6,800	9,000	7,200	8,400	7,500			
105												5,500	8,300	5,900	8,500	6,300	7,500	6,600			
110												4,700	7,600	5,100	7,700	5,500	6,600	5,800			
115														4,400	6,900	4,800	5,900	5,000			
120														3,800	6,300	4,100	5,300	4,400			
125														3,300	5,800	3,500	4,700	3,800			
130																3,000	4,100	3,300			
135																2,600	3,700	2,800			
140																2,200	3,300	2,300			
145																		1,900			
150																		1,600			
155																		1,300			
D		0°										10°	0°	12°	0°	15°	13°	18°			
Telescoping mode		1, 2	1	1	2	1	2	1	2	1	2	1	2	1	2	1	2	1, 2			
2nd Boom		0	50	100	0	100	0	100	0	100	0	100	0	100	0	100	50	100			
3rd Boom		0	0	0	33	16	50	33	67	50	83	67	100	83	100	100	100				
4th Boom		0	0	0	33	16	50	33	67	50	83	67	100	83	100	100	100				
Top Boom		0	0	0	33	16	50	33	67	50	83	67	100	83	100	100	100				

SMART CW2		COUNTERWEIGHT 24,700lbs (11.2 t) ON OUTRIGGERS FULLY EXTENDED 23' 11-3/8" (7.3 m) SPREAD 360° ROTATION SMART CW2																			
		A	42.0' (12.8 m)		57.7' (17.6 m)		73.3' (22.4 m)		89.0' (27.1 m)		104.7' (31.9 m)		120.3' (36.7 m)		136.0' (41.5 m)						
C		B	B	B	B	B	B	B	B	B	B	B	B	B							
0°		35.2	19,700	50.7	10,900	66.1	4,600	66.1	9,500	81.7	3,200	81.8	6,700	97.2	1,800	97.2	5,200				
Telescoping mode		1, 2	1	1	2	1	2	1	2	1	2	1	2	2	2						

A: Boom length in feet
 B: Load radius in feet
 C: Loaded boom angle (°)
 D: Minimum boom angle (°) for indicated length (no load)

NOTE: The lifting capacity data stored in the LOAD MOMENT INDICATOR (AML-E2) is based on the standard number of parts of line listed in the chart. Standard number of parts of line for each boom length should be according to the following table.

Boom length in feet (meters)	42.0' (12.8 m)	42.0' to 73.3' (12.8 m to 22.4 m)	73.3' to 167.3' (22.4 m to 51 m)	Single top jib
Telescoping mode	1, 2	1	2	1, 2
Number of parts of line	16	8	4	1

GR-1000XLL-4 RATED LIFTING CAPACITIES (IN POUNDS)

		COUNTERWEIGHT 24,700lbs (11.2 t) ON OUTRIGGERS FULLY EXTENDED 23' 11-3/8" (7.3 m) SPREAD														
		SMART CHART SMART CW2														
B	A	42.0' (12.8 m)	57.7' (17.6 m)	73.3' (22.4 m)		89.0' (27.1 m)		104.7' (31.9 m)		120.3' (36.7 m)		136.0' (41.5 m)		151.7' (46.2 m)		167.3' (51 m)
	8		200,000	99,600												
10		183,400	99,600	74,800	33,800											
12		161,000	99,600	74,800	33,800											
15		135,100	99,600	74,800	33,800	39,900	29,700									
20		103,900	99,600	74,200	33,800	39,900	29,700	33,800	27,700	30,000	27,600					
25		80,100	79,500	62,300	33,800	39,900	29,700	33,800	27,700	30,000	27,600	28,300	27,500			
30		63,300	62,500	53,400	33,800	39,900	29,700	33,800	27,700	30,000	27,600	28,300	26,100	26,400	24,100	
35			49,900	46,500	33,800	39,300	29,700	33,800	27,700	30,000	27,400	28,300	23,900	26,400	23,600	20,700
40			41,000	40,300	33,800	34,600	29,700	31,200	27,700	28,800	25,000	27,100	21,500	25,400	22,000	20,700
45			34,300	33,600	33,800	30,700	29,700	27,600	26,300	25,500	23,000	24,000	19,500	22,900	20,500	20,100
50			29,200	28,400	33,200	27,500	29,700	24,700	23,900	22,800	21,200	21,400	17,800	20,400	19,100	19,000
55				24,200	29,000	24,800	29,600	22,300	22,000	20,500	19,800	19,200	16,300	18,300	17,600	17,600
60				20,200	25,600	22,200	26,200	20,200	20,300	18,500	18,200	17,400	15,000	16,500	16,200	15,800
65				17,100	22,600	18,900	23,300	18,300	18,800	16,800	16,900	15,700	14,000	14,900	15,100	14,300
70						16,100	20,500	16,800	17,600	15,400	15,700	14,300	13,000	13,600	14,100	13,000
75						13,900	18,200	15,000	16,400	14,100	14,700	13,100	12,100	12,400	13,200	11,800
80						11,900	16,200	13,000	15,500	12,900	13,700	12,000	11,400	11,300	12,400	10,800
85								11,300	14,600	11,900	12,900	11,000	10,700	10,400	11,700	9,900
90								9,900	13,400	10,600	12,200	10,100	10,100	9,500	11,000	9,000
95								8,600	12,100	9,300	11,500	9,300	9,500	8,700	10,300	8,300
100										8,200	11,000	8,600	9,000	8,000	9,700	7,600
105										7,200	10,100	7,700	8,600	7,400	9,100	7,000
110										6,300	9,300	6,800	8,200	6,800	8,300	6,400
115												6,000	7,800	6,300	7,500	5,900
120												5,300	7,500	5,600	6,800	5,400
125												4,700	7,200	5,000	6,100	5,000
130														4,400	5,500	4,600
135														3,800	5,000	4,100
140														3,400	4,500	3,600
145																3,100
150																2,700
155																2,400
D		0°								9°	0°	11°	0°	13°	12°	16°
Telescoping mode		1, 2	1	1	2	1	2	1	2	1	2	1	2	1	2	1, 2
2nd Boom		0	50	100	0	100	0	100	0	100	0	100	0	100	50	100
3rd Boom		0	0	0	33	16	50	33	67	50	83	67	100	83	100	100
4th Boom		0	0	0	33	16	50	33	67	50	83	67	100	83	100	100
Top Boom		0	0	0	33	16	50	33	67	50	83	67	100	83	100	100

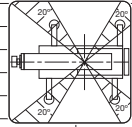

		COUNTERWEIGHT 24,700lbs (11.2 t) ON OUTRIGGERS FULLY EXTENDED 23' 11-3/8" (7.3 m) SPREAD																		
		SMART CHART SMART CW2																		
C	A	42.0' (12.8 m)	57.7' (17.6 m)	73.3' (22.4 m)		89.0' (27.1 m)		104.7' (31.9 m)		120.3' (36.7 m)		136.0' (41.5 m)								
	0°	35.2	19,700	50.7	10,900	66.1	4,600	66.1	9,500	81.7	3,400	81.7	7,000	97.2	2,000	97.2	5,400			
Telescoping mode		1, 2	1	1	2	1	2	1	2	1	2	1	2							

A: Boom length in feet
 B: Load radius in feet
 C: Loaded boom angle (°)
 D: Minimum boom angle (°) for indicated length (no load)

NOTE: The lifting capacity data stored in the LOAD MOMENT INDICATOR (AML-E2) is based on the standard number of parts of line listed in the chart. Standard number of parts of line for each boom length should be according to the following table.

Boom length in feet (meters)	42.0' (12.8 m)	42.0' to 73.3' (12.8 m to 22.4 m)	73.3' to 167.3' (22.4 m to 51 m)	Single top jib
Telescoping mode	1, 2	1	2	1, 2
Number of parts of line	16	8	4	1

GR-1000XLL-4 RATED LIFTING CAPACITIES (IN POUNDS)

COUNTERWEIGHT 24,700 lbs (11.2 t) ON OUTRIGGERS FULLY EXTENDED 23' 11-3/8" (7.3 m) SPREAD 360° ROTATION SMART CW1						
B	167.3' (51 m) Boom + 33.2' (10.1 m) JIB			167.3' (51 m) Boom + 58.1' (17.7 m) JIB		
	3.5° Offset	25° Offset	45° Offset	3.5° Offset	25° Offset	45° Offset
45	10,400					
50	10,400					
55	10,400			6,700		
60	10,400			6,700		
65	10,400	10,400		6,700		
70	10,400	10,400		6,700		
75	10,400	10,200		6,700	6,200	
80	10,400	9,500		6,700	6,100	
85	9,800	9,000		6,700	5,900	
90	9,200	8,500		6,700	5,800	4,800
95	8,500	8,000		6,700	5,600	4,700
100	7,500	7,600		6,700	5,500	4,600
105	6,700	7,200		6,600	5,400	4,500
110	5,800	6,700		6,200	5,300	4,400
115	5,100	5,900		5,400	5,200	4,300
120	4,500	5,200		4,800	5,000	4,200
125	3,900	4,500		4,200	4,900	4,200
130	3,300	3,900		3,600	4,600	4,100
135	2,800	3,400		3,100	4,200	4,000
140	2,400	2,800		2,700	3,700	4,000
145	1,900	2,400		2,200	3,200	3,800
150	1,500	1,900		1,900	2,700	3,200
155		1,500		1,500	2,300	2,800
160					1,900	2,300
165					1,500	1,900
170						1,500
Telescoping mode	1, 2	1, 2	1, 2	1, 2	1, 2	1, 2

COUNTERWEIGHT 24,700 lbs (11.2 t) ON OUTRIGGERS FULLY EXTENDED 23' 11-3/8" (7.3 m) SPREAD 360° ROTATION SMART CW1						
B	151.7' (46.2 m) Boom + 33.2' (10.1 m) JIB			151.7' (46.2 m) Boom + 58.1' (17.7 m) JIB		
	3.5° Offset	25° Offset	45° Offset	3.5° Offset	25° Offset	45° Offset
40	12,500	11,500				
45	12,500	11,500				
50	12,500	11,500				
55	12,500	11,500	12,500	11,500		
60	12,500	11,500	12,500	11,500	10,000	10,000
65	12,500	11,500	12,100	11,100	9,800	9,700
70	12,500	11,500	11,700	10,300	9,600	9,500
75	12,500	10,900	11,400	9,700	9,400	9,200
80	11,700	10,300	11,000	9,100	9,200	8,600
85	10,700	9,800	10,700	8,500	9,100	8,200
90	9,800	8,600	10,100	8,000	8,900	7,700
95	8,700	8,000	9,300	7,600	8,800	7,300
100	7,700	7,600	8,600	7,100	8,700	6,900
105	6,800	7,100	7,600	6,800	8,000	6,600
110	6,000	6,700	6,700	6,400	7,200	6,200
115	5,200	6,200	6,000	6,100	6,300	6,000
120	4,600	5,600	5,200	5,800	5,600	5,700
125	4,000	5,000	4,600	5,400	4,900	5,400
130	3,400	4,400	3,900	4,900	4,200	5,000
135	2,900	3,900	3,400	4,300	3,600	4,500
140	2,400	3,400	2,900	3,800		
145	2,000	3,000	2,400	3,300		
150	1,600	2,600	2,000	2,900		
155	1,300	2,200	1,500	2,400		
160	900	1,900	1,100	2,100		
165		1,500		1,700		
170		1,300				
175		1,000				
180						
185						
Telescoping mode	1	2	1	2	1	2

COUNTERWEIGHT 24,700 lbs (11.2 t) ON OUTRIGGERS FULLY EXTENDED 23' 11-3/8" (7.3 m) SPREAD 360° ROTATION SMART CW1						
B	120.3' (36.7 m) Boom + 33.2' (10.1 m) JIB			120.3' (36.7 m) Boom + 58.1' (17.7 m) JIB		
	3.5° Offset	25° Offset	45° Offset	3.5° Offset	25° Offset	45° Offset
30	14,600	14,600				
35	14,600	14,600				
40	14,600	14,600	14,400			
45	14,600	14,600	13,800	13,600		
50	14,600	14,600	13,200	13,000	10,400	10,400
55	14,600	14,600	12,700	12,500	10,200	10,100
60	14,600	14,400	12,200	12,000	9,900	9,800
65	14,600	13,400	11,800	11,600	9,700	9,600
70	14,600	12,600	11,400	11,200	9,500	9,400
75	13,900	12,400	11,000	10,800	9,300	9,200
80	12,400	11,700	10,700	10,500	9,200	9,100
85	10,900	11,000	10,400	10,200	9,000	8,900
90	9,600	10,300	10,100	9,900	8,900	8,800
95	8,500	9,800	9,300	9,700	8,800	8,700
100	7,500	9,300	8,200	9,200	8,600	8,600
105	6,600	8,800	7,200	8,700	7,600	8,500
110	5,800	7,900	6,300	8,300	6,600	8,300
115	5,000	7,200	5,500	7,600	5,800	7,800
120	4,400	6,500	4,800	6,900		
125	3,700	5,900	4,100	6,200		
130	3,200	5,400	3,500	5,600		
135	2,700	4,900	2,900	5,000		
140	2,200	4,400				
145	1,800	4,000				
150						
155						
160						
165						
170						
Telescoping mode	1	2	1	2	1	2

B: Load radius in feet

GR-1000XLL-4 RATED LIFTING CAPACITIES (IN POUNDS)

B		167.3' (51 m) Boom + 33.2' (10.1 m) JIB			167.3' (51 m) Boom + 58.1' (17.7 m) JIB			
		3.5° Offset	25° Offset	45° Offset	3.5° Offset	25° Offset	45° Offset	45° Offset
45	10,400							
50	10,400							
55	10,400				6,700			
60	10,400				6,700			
65	10,400		10,400		6,700			
70	10,400		10,400	9,800	6,700			
75	10,400		10,200	9,400	6,700		6,200	
80	10,400		9,500	9,000	6,700		6,100	
85	9,800		9,000	8,500	6,700		5,900	
90	9,200		8,500	8,100	6,700		5,800	4,800
95	8,700		8,000	7,700	6,700		5,600	4,700
100	7,900		7,600	7,300	6,700		5,500	4,600
105	7,200		7,200	6,900	6,600		5,400	4,500
110	6,300		6,800	6,600	6,200		5,300	4,400
115	5,600		6,300	6,300	5,800		5,200	4,300
120	4,900		5,600	6,000	5,200		5,000	4,200
125	4,300		4,900	5,300	4,600		4,900	4,200
130	3,700		4,300	4,700	4,100		4,600	4,100
135	3,200		3,800	4,100	3,500		4,400	4,000
140	2,800		3,200	3,500	3,100		4,100	4,000
145	2,300		2,800	3,000	2,600		3,500	3,900
150	1,900		2,300	2,500	2,200		3,100	3,600
155	1,500		1,900		1,900		2,600	3,100
160	1,200		1,500		1,500		2,200	2,700
165			1,100				1,900	2,200
170							1,500	1,800
175								1,400
Telescoping mode	1, 2	1, 2	1, 2		1, 2	1, 2	1, 2	1, 2

B		151.7' (46.2 m) Boom + 33.2' (10.1 m) JIB			151.7' (46.2 m) Boom + 58.1' (17.7 m) JIB					
		3.5° Offset	25° Offset	45° Offset	3.5° Offset	25° Offset	45° Offset	45° Offset	45° Offset	45° Offset
40	12,500	11,500								
45	12,500	11,500								
50	12,500	11,500								
55	12,500	11,500	12,500	11,500						
60	12,500	11,500	12,500	11,500	10,000	10,000				
65	12,500	11,500	12,100	11,100	9,800	9,700				
70	12,500	11,500	11,700	10,300	9,600	9,500				
75	12,500	10,900	11,400	9,700	9,400	9,200				
80	11,700	10,300	11,000	9,100	9,200	8,600				
85	10,700	9,800	10,700	8,500	9,100	8,200				
90	9,800	8,600	10,100	8,000	8,900	7,700				
95	9,000	8,000	9,300	7,600	8,800	7,300				
100	8,200	7,600	8,600	7,100	8,700	6,900				
105	7,300	7,100	7,900	6,800	8,000	6,600				
110	6,500	6,700	7,200	6,400	7,400	6,200				
115	5,700	6,300	6,400	6,100	6,800	6,000				
120	5,000	6,000	5,600	5,800	6,000	5,700				
125	4,400	5,400	5,000	5,500	5,200	5,400				
130	3,800	4,800	4,400	5,200	4,600	5,200				
135	3,300	4,300	3,800	4,700	4,000	4,800				
140	2,800	3,800	3,300	4,100						
145	2,400	3,300	2,800	3,600						
150	2,000	2,900	2,300	3,200						
155	1,600	2,500	1,900	2,800						
160	1,300	2,200	1,500	2,400						
165		1,900	1,100	2,000						
170		1,500								
175		1,300								
180										
185										
Telescoping mode	1	2	1	2	1	2	1	2	1	2

B		120.3' (36.7 m) Boom + 33.2' (10.1 m) JIB			120.3' (36.7 m) Boom + 58.1' (17.7 m) JIB					
		3.5° Offset	25° Offset	45° Offset	3.5° Offset	25° Offset	45° Offset	45° Offset	45° Offset	45° Offset
30	14,600	14,600								
35	14,600	14,600								
40	14,600	14,600	14,400							
45	14,600	14,600	13,800	13,600						
50	14,600	14,600	13,200	13,000	10,400	10,400				
55	14,600	14,600	12,700	12,500	10,200	10,100				
60	14,600	14,400	12,200	12,000	9,900	9,800				
65	14,600	13,400	11,800	11,600	9,700	9,600				
70	14,600	12,600	11,400	11,200	9,500	9,400				
75	13,900	12,400	11,000	10,800	9,300	9,200				
80	12,800	11,700	10,700	10,500	9,200	9,100				
85	11,500	11,000	10,400	10,200	9,000	8,900				
90	10,200	10,300	10,100	9,900	8,900	8,800				
95	9,000	9,800	9,800	9,700	8,800	8,700				
100	8,000	9,300	8,700	9,200	8,700	8,600				
105	7,000	8,800	7,700	8,700	8,000	8,500				
110	6,200	8,300	6,800	8,300	7,100	8,300				
115	5,400	7,600	6,000	7,900	6,200	7,900				
120	4,800	6,900	5,200	7,300						
125	4,100	6,300	4,500	6,600						
130	3,600	5,800	3,900	6,000						
135	3,100	5,200	3,300	5,400						
140	2,600	4,700								
145	2,200	4,300								
150										
155										
160										
165										
170										
Telescoping mode	1	2	1	2	1	2	1	2	1	2

B: Load radius in feet

GR-1000XLL-4 RATED LIFTING CAPACITIES (IN POUNDS)

		COUNTERWEIGHT 24,700 lbs (11.2 t) ON OUTRIGGERS FULLY EXTENDED 23' 11-3/8" (7.3 m) SPREAD SMART CHART SMART CW2					
B	167.3' (51 m) Boom + 33.2' (10.1 m) JIB			167.3' (51 m) Boom + 58.1' (17.7 m) JIB			
	3.5° Offset	25° Offset	45° Offset	3.5° Offset	25° Offset	45° Offset	
45	10,400						
50	10,400						
55	10,400			6,700			
60	10,400	10,400		6,700			
65	10,400	10,400	9,800	6,700			
70	10,400	10,400	9,600	6,700			
75	10,400	10,200	9,400	6,700	6,200		
80	10,400	9,500	9,000	6,700	6,100		
85	9,800	9,000	8,500	6,700	5,900		
90	9,200	8,500	8,100	6,700	5,800	4,800	
95	8,700	8,000	7,700	6,700	5,600	4,700	
100	7,900	7,600	7,300	6,700	5,500	4,600	
105	7,300	7,200	6,900	6,600	5,400	4,500	
110	6,700	6,800	6,600	6,200	5,300	4,400	
115	6,100	6,500	6,300	5,800	5,200	4,300	
120	5,600	5,900	6,000	5,500	5,000	4,200	
125	5,100	5,400	5,600	5,200	4,900	4,200	
130	4,700	5,000	5,100	4,900	4,600	4,100	
135	4,300	4,600	4,700	4,500	4,400	4,000	
140	3,900	4,200	4,300	4,100	4,200	4,000	
145	3,500	3,800	3,900	3,700	4,000	3,900	
150	3,100	3,400	3,500	3,400	3,800	3,700	
155	2,700	3,100		3,000	3,500	3,500	
160	2,300	2,700		2,600	3,200	3,400	
165	2,000	2,300		2,300	2,900	3,100	
170	1,700	1,900		1,900	2,600	2,800	
175	1,300	1,500		1,600	2,200	2,500	
180	1,100	1,200		1,300	1,900		
185				1,100	1,500		
190					1,200		
Telescoping mode	1, 2	1, 2	1, 2	1, 2	1, 2	1, 2	

		COUNTERWEIGHT 24,700 lbs (11.2 t) ON OUTRIGGERS FULLY EXTENDED 23' 11-3/8" (7.3 m) SPREAD SMART CHART SMART CW2					
B	151.7' (46.2 m) Boom + 33.2' (10.1 m) JIB			151.7' (46.2 m) Boom + 58.1' (17.7 m) JIB			
	3.5° Offset	25° Offset	45° Offset	3.5° Offset	25° Offset	45° Offset	
40	12,500	11,500					
45	12,500	11,500					
50	12,500	11,500					
55	12,500	11,500	12,500	11,500			
60	12,500	11,500	12,500	11,500	10,000	10,000	
65	12,500	11,500	12,100	11,100	9,800	9,700	
70	12,500	11,500	11,700	10,300	9,600	9,500	
75	12,500	10,900	11,400	9,700	9,400	9,200	
80	11,700	10,300	11,000	9,100	9,200	8,600	
85	10,700	9,800	10,700	8,500	9,100	8,200	
90	9,800	8,600	10,100	8,000	8,900	7,700	
95	9,000	8,000	9,300	7,600	8,800	7,300	
100	8,200	7,600	8,600	7,100	8,700	6,900	
105	7,600	7,100	7,900	6,800	8,000	6,600	
110	7,000	6,700	7,300	6,400	7,400	6,200	
115	6,400	6,300	6,700	6,100	6,800	6,000	
120	5,900	6,000	6,200	5,800	6,300	5,700	
125	5,400	5,700	5,700	5,500	5,800	5,400	
130	5,000	5,400	5,200	5,200	5,300	5,200	
135	4,600	5,100	4,800	5,000	4,900	4,900	
140	4,100	4,900	4,400	4,700			
145	3,600	4,500	3,900	4,500			
150	3,200	4,100	3,400	4,300			
155	2,700	3,600	3,000	3,900			
160	2,300	3,200	2,500	3,400			
165	2,000	2,900	2,100	3,000			
170	1,600	2,500					
175	1,300	2,200					
180							
185							
190							
Telescoping mode	1, 2	2	1, 2	1, 2	1, 2	2	

		COUNTERWEIGHT 24,700 lbs (11.2 t) ON OUTRIGGERS FULLY EXTENDED 23' 11-3/8" (7.3 m) SPREAD SMART CHART SMART CW2					
B	120.3' (36.7 m) Boom + 33.2' (10.1 m) JIB			120.3' (36.7 m) Boom + 58.1' (17.7 m) JIB			
	3.5° Offset	25° Offset	45° Offset	3.5° Offset	25° Offset	45° Offset	
30	14,600	14,600					
35	14,600	14,600					
40	14,600	14,600	14,400				
45	14,600	14,600	13,800	13,600			
50	14,600	14,600	13,200	13,000	10,400	10,400	
55	14,600	14,600	12,700	12,500	10,200	10,100	
60	14,600	14,400	12,200	12,000	9,900	9,800	
65	14,600	13,400	11,800	11,600	9,700	9,600	
70	14,600	12,600	11,400	11,200	9,500	9,400	
75	13,900	12,400	11,000	10,800	9,300	9,200	
80	12,800	11,700	10,700	10,500	9,200	9,100	
85	11,700	11,000	10,400	10,200	9,000	8,900	
90	10,800	10,300	10,100	9,900	8,900	8,800	
95	10,000	9,800	9,900	9,700	8,800	8,700	
100	9,200	9,300	9,400	9,200	8,700	8,600	
105	8,500	8,800	8,700	8,700	8,600	8,500	
110	7,900	8,300	8,100	8,300	8,200	8,300	
115	7,000	7,900	7,500	7,900	7,600	7,900	
120	6,300	7,500	6,700	7,500			
125	5,600	7,200	6,000	7,200			
130	4,900	6,900	5,200	6,800			
135	4,300	6,500	4,600	6,500			
140	3,800	6,000					
145	3,300	5,500					
150							
155							
160							
165							
170							
Telescoping mode	1, 2	2	1, 2	1, 2	1, 2	2	

B: Load radius in feet

SMART COUNTERWEIGHT

You can increase the capacity by changing the mounting position of the counterweight.

SMART CW 1 status

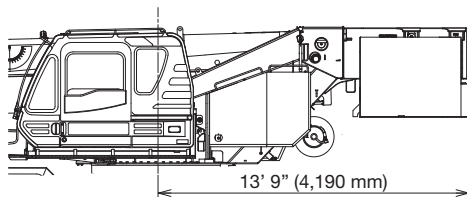

SMART CW 2 status

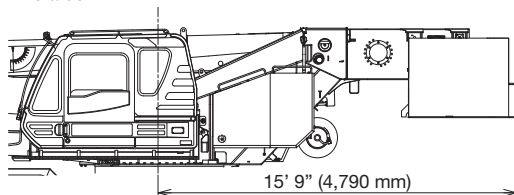

- SMART CW 1: Counterweight is mounted at the front.
- SMART CW 2: Counterweight is mounted at the rear.

WARNING AND OPERATING INSTRUCTIONS FOR LIFTING CAPACITIES

GENERAL

1. RATED LIFTING CAPACITIES apply only to the machine as originally manufactured and normally equipped by TADANO LTD. Modifications to the machine or use of optional equipment other than that specified can result in a reduction of capacity.
2. Hydraulic cranes can be hazardous if improperly operated or maintained. Operation and maintenance of this machine must be in compliance with information, in the Operation Manual supplied with the crane. If this manual is missing, order a replacement through the distributor.
3. The operator and other personnel associated with this machine shall fully acquaint themselves with the latest American National Standards Institute (ANSI) safety standards for cranes.

SET UP

1. Rated lifting capacities on the chart are the maximum allowable crane capacities and are based on the machine standing level on firm supporting surface under ideal job conditions. Depending on the nature of the supporting surface, it may be necessary to have structural supports under the outrigger floats or tires to spread the loads to a larger bearing surface.
2. For outrigger operation, outriggers shall be properly extended with tires free of supporting surface before operating crane.

OPERATION

1. Rated lifting capacities have been tested to and meet minimum requirements of SAE J1063-Cantilevered Boom Crane Structures Method of Test.
Rated lifting capacities do not exceed 85% of the tipping load on outriggers fully extended as determined by SAE J765-Crane Stability Test Code.
2. Rated lifting capacities for partially extended outriggers are determined from the formula, Rated Lifting Capacities = (Tipping Load - $0.1 \times$ Tip Reaction) / 1.25.
3. Rated lifting capacities are based on actual load radius increased by boom deflection.
4. The weight of handling device such as hook blocks, slings, etc., must be considered as part of the load and must be deducted from the lifting capacities.
5. Rated lifting capacities are based on freely suspended loads and make no allowance for such factors as the effect of wind, sudden stopping of loads, supporting surface conditions, inflation of tires, operating speeds, side loads, etc. Side pull on boom or jib is extremely dangerous.
Such action can damage the boom, jib or slewing mechanism, and lead to overturning of the crane.
6. Rated lifting capacities do not account for wind on lifted load or boom. We recommend against working under the condition that the load is out of control due to a strong wind. During boom lift, consider that the rated lifting capacity is reduced by 50% when the wind speed is 20 mph (9 m/s) to 27 mph (12 m/s); reduced by 70% when the wind speed is 27 mph (12 m/s) to 31 mph (14 m/s). If the wind speed is 31 mph (14 m/s) or over, stop operation. During jib lift, stop operation if the wind speed is 20 mph (9 m/s) or over.
7. Rated lifting capacities at load radius shall not be exceeded. Do not tip the crane to determine allowable loads.
8. Do not operate at boom lengths, radii, or boom angle, where no capacities are shown. Crane may overturn without any load on the hook.
9. When boom length is between values listed, refer to the rated lifting capacities of the next longer and next shorter booms for the same radius. The lesser of the two rated lifting capacities shall be used.
10. When making lifts at a load radius not shown, use the next longer radius to determine allowable capacity.
11. Load per line should not exceed 14,600 lbs. (6,600 kg) for main winch and auxiliary winch.
12. Check the actual number of parts of line with LOAD MOMENT INDICATOR (AML-E2) before operation. Maximum lifting capacity is restricted by the number of parts of line of LOAD MOMENT INDICATOR (AML-E2). Limited capacity is as determined from the formula, Single line pull for main winch 14,600 lbs. (6,600 kg) \times number of parts of line.

13. The boom angle before loading should be greater to account for deflection. For rated lifting capacities, the loaded boom angle and the load radius is for reference only.
14. The 42.0' (12.8 m) boom length capacities are based on boom fully retracted. If not fully retracted [less than 57.7' (17.6 m) boom length], use the rated lifting capacities for the 57.7' (17.6 m) boom length.
15. Extension or retraction of the boom with loads may be attempted within the limits of the RATED LIFTING CAPACITIES.
The ability to telescope loads is limited by hydraulic pressure, boom angle, boom length, crane maintenance, etc.
For lifting capacity of single top, deduct the weight of the load handling equipment from the rated lifting capacity of the boom.
16. For the lifting capacity of single top, the net capacity shall not exceed 14,600 lbs. (6,600 kg) including the main boom hook mass attached to the boom.
17. When the base jib or top jib or both jibs are removed, set the jib state switch to the REMOVED position.
18. When erecting and stowing jib, be sure to retain it by hand or by other means to prevent its free movement.
19. Use "ANTI-TWOBLOCK" disable switch when erecting and stowing jib and when stowing hook block. While the switch is pushed, the hoist does not stop, even when overwind condition occurs.
20. When lifting a load by using jib (aux. winch) and boom (main winch) simultaneously, do the following:
 - Enter the operation status as jib operation, not as boom operation.
 - Before starting operation, make sure that mass of load is within rated lifting capacity for jib.
21. Before telescoping the boom, set the telescoping mode selector switch to mode 1 or mode 2 fully retracted.
A change of the telescoping mode is not permissible when the boom has been partially or fully extended.
22. Crane operation is prohibited without full counterweight 24,700 lbs. (11.2 ton) installed. Outriggers shall be extended 23' 11-3 / 8" (7.3 m) spread when installing or removing removable counterweight.

DEFINITIONS

1. Load Radius: Horizontal distance from a projection of the axis of rotation to supporting surface before loading to the center of the vertical hoist line or tackle with load applied.
2. Loaded Boom Angle: The angle between the boom base section and the horizontal, after lifting the rated lifting capacity at the load radius.
3. Working Area: Area measured in a circular arc about the centerline of rotation.
4. Freely Suspended Load: Load hanging free with no direct external force applied except by the hoist line.
5. Side Load: Horizontal side force applied to the lifted load either on the ground or in the air.

GR-1000XLL-4 RATED LIFTING CAPACITIES (IN POUNDS)

COUNTERWEIGHT 24,700lbs (11.2 t) ON RUBBER STATIONARY SMART CW1									
Over front					360° Rotation				
B \ A	42.0' (12.8 m)	73.3' (22.4 m)	89.0' (27.1 m)	104.7' (31.9 m)	B \ A	42.0' (12.8 m)	73.3' (22.4 m)	89.0' (27.1 m)	104.7' (31.9 m)
12	65,000				12	43,000			
15	53,700				15	32,600			
20	40,400	33,800	29,700		20	19,400	22,900	22,900	
25	31,400	33,800	29,700	27,700	25	12,500	15,700	16,400	16,800
30	24,200	27,300	27,800	27,700	30	8,100	11,200	11,800	12,200
35		21,200	21,700	22,000	35		8,100	8,700	9,100
40		16,800	17,400	17,800	40		5,800	6,400	6,800
45		13,600	14,200	14,500	45		4,100	4,700	5,100
50		11,100	11,600	12,000	50		2,800	3,400	3,700
55		9,100	9,700	10,000	55		1,700	2,300	2,600
60		7,500	8,000	8,400	60				
65		6,200	6,700	7,100	65				
70			5,600	5,900	70				
75			4,700	5,000	75				
80			3,900	4,200	80				
85				3,400	85				
90				2,800	90				
95				2,300	95				
D	0°				D	0°	29°	43°	50°
Telescoping mode	1, 2	2	2	2	Telescoping mode	1, 2	2	2	2
2nd Boom	0	0	0	0	2nd Boom	0	0	0	0
3rd Boom	0	33	50	67	3rd Boom	0	33	50	67
4th Boom	0	33	50	67	4th Boom	0	33	50	67
Top Boom	0	33	50	67	Top Boom	0	33	50	67

COUNTERWEIGHT 24,700lbs (11.2 t) ON RUBBER STATIONARY SMART CW1									
C \ A	42.0' (12.8 m)		73.3' (22.4 m)		89.0' (27.1 m)		104.7' (31.9 m)		
0°	35.2	18,400	66.1	5,100	81.8	3,300	97.2	2,200	

COUNTERWEIGHT 24,700lbs (11.2 t) ON RUBBER CREEP SMART CW1									
Over front									
B \ A	42.0' (12.8 m)	73.3' (22.4 m)	89.0' (27.1 m)	104.7' (31.9 m)					
12	50,600								
15	41,400								
20	30,400	33,300	29,700						
25	23,200	26,100	26,700	27,000					
30	17,900	20,900	21,500	21,900					
35		17,000	17,600	17,900					
40		13,900	14,500	14,900					
45		11,400	12,000	12,400					
50		9,400	10,000	10,400					
55		7,700	8,300	8,700					
60		6,300	6,900	7,300					
65		5,100	5,700	6,100					
70			4,700	5,000					
75			3,800	4,100					
80			3,000	3,300					
85				2,600					
90				2,000					
95				1,500					
D	0°								
Telescoping mode	1, 2	2	2	2					
2nd Boom	0	0	0	0					
3rd Boom	0	33	50	67					
4th Boom	0	33	50	67					
Top Boom	0	33	50	67					

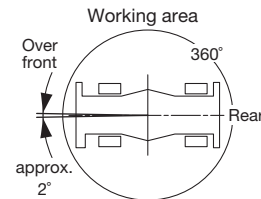

- A: Boom length in feet
- B: Load radius in feet
- C: Loaded boom angle (°)
- D: Minimum boom angle (°) for indicated length (no load)

NOTE: The lifting capacity data stored in the LOAD MOMENT INDICATOR (AML-E2) is based on the standard number of parts of line listed in the chart.
Standard number of parts of line for on-rubber operation should be according to the chart.

COUNTERWEIGHT 24,700lbs (11.2 t) ON RUBBER CREEP SMART CW1									
C \ A	42.0' (12.8 m)		73.3' (22.4 m)		89.0' (27.1 m)		104.7' (31.9 m)		
0°	35.2	13,800	66.1	4,200	81.8	2,400	97.2	1,400	

Boom length in feet (meters)	42.0' (12.8 m)	42.0' to 104.7' (12.8 m to 31.9 m)	Single top jib
Number of parts of line	6	4	1

GR-1000XLL-4 RATED LIFTING CAPACITIES (IN POUNDS)

COUNTERWEIGHT 24,700lbs (11.2 t) ON RUBBER STATIONARY SMART CW2									
Over front					360° Rotation				
B \ A	42.0' (12.8 m)	73.3' (22.4 m)	89.0' (27.1 m)	104.7' (31.9 m)	B \ A	42.0' (12.8 m)	73.3' (22.4 m)	89.0' (27.1 m)	104.7' (31.9 m)
12	67,600				12				
15	56,000				15				
20	42,300	33,800	29,700		20	21,800			
25	33,000	33,800	29,700	27,700	25	14,200	17,500		
30	25,900	29,000	29,400	27,700	30	9,500	12,600	13,200	13,200
35		22,600	23,000	23,300	35		9,300	9,900	10,300
40		18,000	18,600	18,800	40		6,900	7,500	7,900
45		14,600	15,200	15,500	45		5,000	5,600	6,000
50		12,000	12,500	12,900	50		3,600	4,200	4,600
55		9,900	10,500	10,800	55		2,500	3,000	3,400
60		8,200	8,800	9,100	60		1,500	2,100	2,400
65		6,900	7,400	7,700	65			1,300	
70			6,200	6,500	70				
75			5,200	5,600	75				
80			4,400	4,700	80				
85				3,900	85				
90				3,300	90				
95				2,800	95				
D	0°				D	0°	20°	37°	47°
Telescoping mode	1, 2	2	2	2	Telescoping mode	1, 2	2	2	2
2nd Boom	0	0	0	0	2nd Boom	0	0	0	0
3rd Boom	0	33	50	67	3rd Boom	0	33	50	67
4th Boom	0	33	50	67	4th Boom	0	33	50	67
Top Boom	0	33	50	67	Top Boom	0	33	50	67

COUNTERWEIGHT 24,700lbs (11.2 t) ON RUBBER STATIONARY SMART CW2									
C \ A	42.0' (12.8 m)		73.3' (22.4 m)		89.0' (27.1 m)		104.7' (31.9 m)		
0°	B	(12.8 m)	B	(22.4 m)	B	(27.1 m)	B	(31.9 m)	
0°	35.2	19,900	66.1	5,700	81.8	3,700	97.2	2,600	
0°	35.2	6,200							

COUNTERWEIGHT 24,700lbs (11.2 t) ON RUBBER CREEP SMART CW2									
Over front									
B \ A	42.0' (12.8 m)	73.3' (22.4 m)	89.0' (27.1 m)	104.7' (31.9 m)					
12	53,300								
15	43,600								
20	32,300	33,800	29,700						
25	24,800	27,600	28,200	27,700					
30	19,300	22,300	22,900	23,200					
35		18,100	18,700	19,100					
40		14,900	15,500	15,900					
45		12,300	12,900	13,300					
50		10,200	10,800	11,200					
55		8,500	9,100	9,500					
60		7,000	7,600	8,000					
65		5,800	6,400	6,800					
70			5,300	5,700					
75			4,400	4,700					
80			3,600	3,900					
85				3,200					
90				2,500					
95				2,000					
D	0°								
Telescoping mode	1, 2	2	2	2					
2nd Boom	0	0	0	0					
3rd Boom	0	33	50	67					
4th Boom	0	33	50	67					
Top Boom	0	33	50	67					

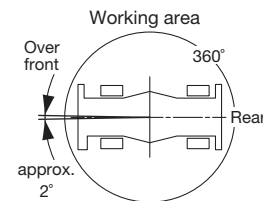

- A: Boom length in feet
- B: Load radius in feet
- C: Loaded boom angle (°)
- D: Minimum boom angle (°) for indicated length (no load)

NOTE: The lifting capacity data stored in the LOAD MOMENT INDICATOR (AML-E2) is based on the standard number of parts of line listed in the chart. Standard number of parts of line for on-rubber operation should be according to the chart.

COUNTERWEIGHT 24,700lbs (11.2 t) ON RUBBER CREEP SMART CW2									
C \ A	42.0' (12.8 m)		73.3' (22.4 m)		89.0' (27.1 m)		104.7' (31.9 m)		
0°	B	(12.8 m)	B	(22.4 m)	B	(27.1 m)	B	(31.9 m)	
0°	35.2	14,700	66.1	4,800	81.8	3,000	97.2	1,900	

Boom length in feet (meters)	42.0' (12.8 m)	42.0' to 104.7' (12.8 m to 31.9 m)	Single top jib
Number of parts of line	6	4	1

WARNING AND OPERATING INSTRUCTIONS FOR ON RUBBER LIFTING CAPACITIES

- Rated lifting capacities on-rubber are in pounds and do not exceed 75% of tipping loads as determined by SAE J765-Crane Stability Test Code.
- Rated lifting capacities shown in the chart are based on condition that crane is set on firm level surfaces with suspension-lock applied. They are based on actual load radius increased by tire deformation and boom deflection.
- If the suspension-lock cylinders contain air, the axle will not be locked completely and rated lifting capacities may not be obtainable. Bleed the cylinders according to the operation safety and maintenance manual.
- Rated lifting capacities are based on proper tire inflation, capacity and condition. Damaged tires are hazardous to safe operation of crane.
- Tires shall be inflated to correct air pressure.
- Over front operation shall be performed within 2 degrees in front of chassis.
- On-rubber lifting with "jib" is not permitted. Maximum permissible boom length is 104.7 ft. (31.9 m).
- When making lift on-rubber stationary, set parking brake.
- For creep operation, boom must be centered over front of machine, slewing lock engaged, and load restrained from slewing. Travel slowly and keep the lifted load as close to the ground as possible, and especially avoid any abrupt steering, accelerating or braking.
- Do not operate the crane while carrying the load.
- Creep is motion for crane not to travel more than 200 ft. (60 m) in any 30 minute period and to travel at the speed of less than 1 mph (1.6 km/h).
- For creep operation, choose the drive mode and proper gear according to the road or working condition.

Tires	Air Pressure
29.5-25 36PR	68 psi. (470 kPa)
29.5-25 40PR	67 psi. (465 kPa)

NOTES FOR LOAD MOMENT INDICATOR (AML-E2)

- Set AML select keys in accordance with the actually operating crane conditions and don't fail to make sure, before crane operation, that the displays on front panel are correct.
- When operating crane on outriggers:
 - Set "P.T.O." switch to "ON".
 - Press the outrigger state select key to register for the outrigger operation. If the display agrees with the actual state, press the set key to register. After the completion of the registration, the display returns to the crane operation status.
 - Press the lift state select key to register the lift state to be used (single top/jib/boom).
 - Each time the lift state select key is pressed, the display changes. If the display agrees with the actual state, press the set key to register. After the completion of the registration, the display returns to the crane operation status.
 - When erecting and stowing jib, select the status of jib set (Jib state indicative symbol lights up).
- When operating crane on-rubber:
 - Set "P.T.O." switch to "ON".
 - Press the outrigger state select key to register for the on-rubber operation. Each time the outrigger state select key is pressed, the display changes. Select the creep operation, the on-rubber state indicator symbol lights up.
 - Press the lift state select key to register the lift state. However, pay attention to the following.
 - For stationary operation.
 - The front capacities are attainable only when the over front position symbol comes on.
 - When the boom is more than 2 degrees from centered over front of chassis, 360° capacities are in effect.
 - When a load is lifted in the front position and then slewed to the side area, make sure the value of the LOAD MOMENT INDICATOR (AML-E2) is below the 360° lifting capacity.
 - For creep operation.
 - The creep capacities are attainable only when boom is in the straight forward position of chassis and the over front position symbol is on. If boom is not in the straight forward position of chassis, never lift load.
- This machine is equipped with an automatic slewing stopping device. (For the details, see Operation Manual.) But, operate very carefully because the automatic slewing stop does not work in the following cases.
 - During on-rubber operation.
 - When the "P.T.O." switch is set to "OVERRIDE" and the "OVERRIDE" key switch outside the cab is on.
- During crane operation, make sure that the displays on front panel are in accordance with actual operating conditions.
- The displayed values of LOAD MOMENT INDICATOR (AML-E2) are based on freely suspended loads and make no allowance for such factors as the effect of wind, sudden stopping of loads, supporting surface conditions, inflation of tire, operating speed, side loads, etc.
For safe operation, it is recommended when extending and lowering boom or slewing, lifting loads shall be appropriately reduced.
- LOAD MOMENT INDICATOR (AML-E2) is intended as an aid to the operator. Under no condition should it be relied upon to replace use of capacity charts and operating instruction. Sole reliance upon LOAD MOMENT INDICATOR (AML-E2) aids in place of good operating practice can cause an accident. The operator must exercise caution to assure safety.
- The lifting capacity differs depending on the outrigger extension width and slewing position.
Work with the capacity corresponding to the outrigger extension width and slewing position.
For the relationship among the outrigger extension width, slewing position and lifting capacities, refer to the working area charts.

GR-1000XLL-4 AXLE WEIGHT DISTRIBUTION CHART

	Pounds			Kilograms		
	GWV	Front	Rear	GWV	Front	Rear
Base machine	123,550	61,600	61,950	56,040	27,940	28,100
Remove:						
1. 7.3 ton (6.6 metric ton) hook block	-360	-550	190	-165	-251	86
2. 100 ton (90.7 metric ton) hook block	-1,900	-3,460	1,590	-850	-1,571	721
3. Top jib	-740	-1,180	440	-336	-534	198
4. Base jib	-1,910	-4,160	2,250	-867	-1,886	1,019
5. Removable Counterweight	-24,700	9,470	-34,160	-11,200	4,296	-15,496



TADANO AMERICA CORPORATION

4242 West Greens Road.
Houston, Texas, 77066 U.S.A.
PHONE: (281) 869-0030
FAX: (281) 869-0040
<http://www.tadanoamerica.com>